



EN

T5 AUTOSHORT BHZ

(230V~50Hz)

5140363A

Original instructions

SIMU S.A.S. au capital de 5 000 000 € - Z.I. Les Giranaux - BP71 - 70103 ARC-LÈS-GRAY CEDEX - FRANCE - RCS VESOUL B 425 650 090 - SIRET 425 650 090 00011 - n° T.V.A.CEE FR 87 425 650 090



These instructions apply to all T5 AUTOSHORT BHZ drive, the different versions of which are available in the current catalogue. **Field of application:** T5 AUTOSHORT BHZ drive are designed to drive all types of roller shutters equipped with stop blocks and rigid links. The installer, who must be a motorisation and home automation professional, must ensure that the drive product is installed in accordance with the standards in force in the country in which it is installed such as EN 13659 relating to roller shutters.

Liability: Before installing and using the drive, please read operating and installation guide carefully. Please read these instructions carefully before installing and using the drive. In addition to following the instructions given in this guide, the instructions detailed in the attached **Safety instructions** document must also be observed. The drive must be installed by a motorisation and home automation professional, according to instructions from Simu and the regulations applicable in the country in which it is commissioned. It is prohibited to use the drive outside the field of application described above. Such use, and any failure to comply with the instructions given in this guide and in the attached **Safety instructions** document, absolves SIMU of any liability and invalidates the warranty. The installer must inform its customers of the operating and maintenance conditions for the drive and must provide them with the instructions for use and maintenance, and the attached **Safety instructions** document, after installing the drive. Any After-Sales Service operation on the drive must be performed by a motorisation and home automation professional. If in doubt when installing the drive, or to obtain additional information, contact a SIMU adviser or go to the website www.simu.com.

1 Installation

Instructions which must be followed by the drive and home automation professional installing the drive:

- Methods of wiring are given by national standards or IEC60364 standard.
- Cables which pass through a metal wall must be protected and isolated using a sheath or sleeve.
- The cable for the motor can be removed. If it is damaged, replace by the same. The cable may only be connected to the motor by qualified personnel. The connector is to be assembled without damaging the contacts. The continuity of the earth connection must be ensured.

Recommendations: Keep a minimum distance of 20 cm between two T5 AUTOSHORT BHZ motors. Keep a minimum distance of 30 cm between T5 AUTOSHORT BHZ motors and BHZ transmitters. A radio appliance using the same frequency (868-870 MHz) may deteriorate our product's performance. To receive information regarding the compatibility of the motor and the roller shutter or/and accessories, contact the roller shutter manufacturer or SIMU.

Drilling of the tube:

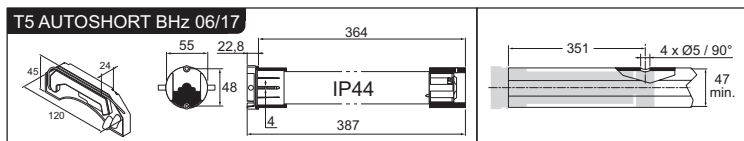

Mounting:

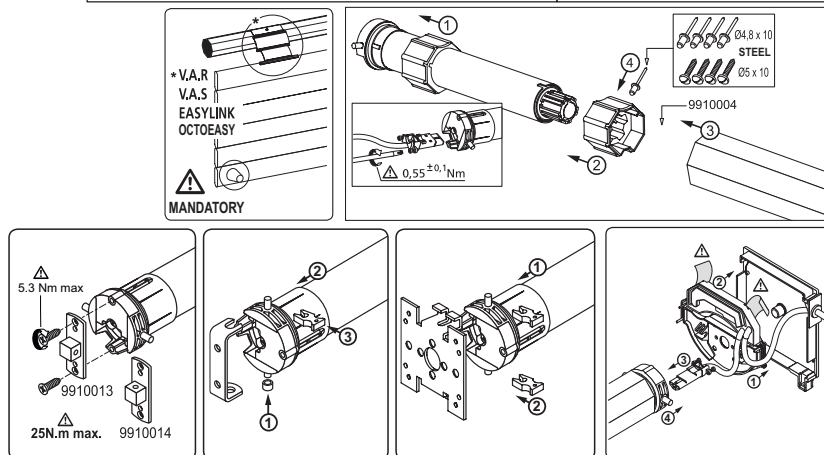

2 Wiring

⚠ - You must have the possibility to switch off individually each motor.

- Attach cables to prevent any contact with moving parts.
- If the motor is used outdoors and if the power supply cable is of the H05-VVF type, then run the cable in a UV-resistant conduit, e.g. trunking.

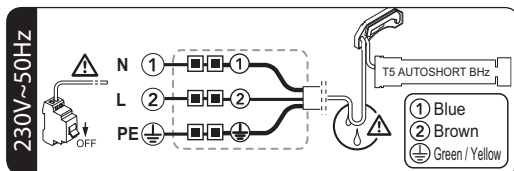

3 Compatible transmitters

(9 transmitters (1 channel) max. for one motor)

- 1 : 1 channel Wall BHz transmitter
- 2 : 1/5 channels Mobile BHz transmitter

i Compatible with io-homecontrol® transmitters;

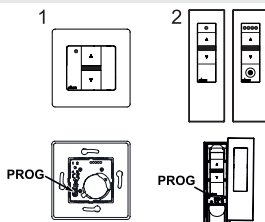

Location of the PROG key on BHz transmitters:

⚠ Do not position the transmitter near metal in order to avoid range losses.

4 Memorizing the automatic settings

⚠ If the installation includes several motors, only one motor is to be powered during this programming procedure. It will avoid interferences with the other motor during the procedure.

4.1- Learning mode:

- Switch the motor ON.
- **Simultaneously** press the "UP" and "DOWN" buttons of a BHz transmitter.

The motor will run for 0,5 second in one direction, then in the other.

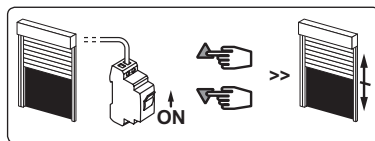

i The transmitter now controls the motor in unstable mode. Move to stage 4.2.

4.2- Checking the rotation direction:

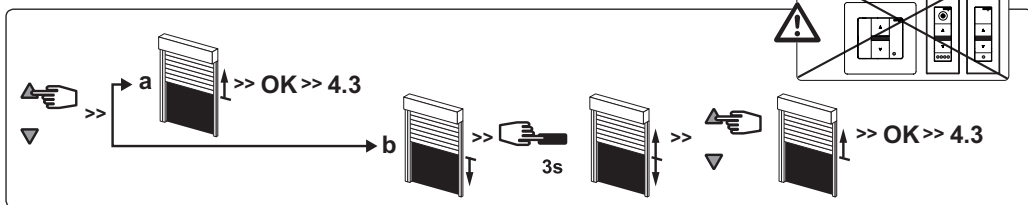

Press the "UP" key of the transmitter:

- a. If the motorized tube runs in the UP direction, move to next stage 4.3.
- b. If the motorized tube runs in the DOWN direction, reverse the rotation direction by pressing the "Stop" key for at least **3 seconds**. The motor will run for 0,5 second in one direction, then in the other direction. Move to the stage 4.3.

4.3- Memorizing the automatic settings:

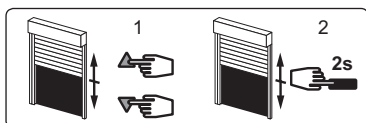

- 1- **Simultaneously** press the "UP" and "DOWN" keys of a transmitter. The motor will run for 0,5 second in one direction and then in the other.
- 2- Press the "Stop" key for **2 s**. The motor will run for 0,5 second in one direction and then in the other. The operation is completed. Go to stage §5.

⚠ If you do not want to use this transmitter as the individual control:

- cut the power supply (2 seconds minimum).

- repeat the operation 4.1* with a new transmitter and then go to step §5.

* In this case, the motor will run for 0,5 second in both directions, that means the limits setting is already done.

5 Programming the first individual control point

⚠ This operation can only be performed from the transmitter that was used for operation 4.1.

- Press the transmitter **PROG** button for approximately **one second**. The motor will run for 0,5 second in one direction and then in the other.

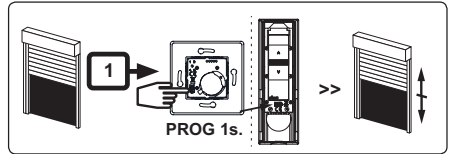

i Your transmitter is now programmed to control the motor in stable mode.

6 Programming a new (individual, group or general) control point

6.1- Open the memory of the receiver from the control transmitter:

- Press the **PROG** key of the transmitter for about **3 seconds**. The motor will run for 0,5 second in one direction and then in the other.

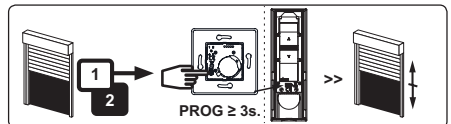

6.2- Confirm the operation from the new transmitter you want to program:

- Press the **PROG** key of the transmitter for **1 second**. The motor will run for 0,5 second in one direction and then in the other.

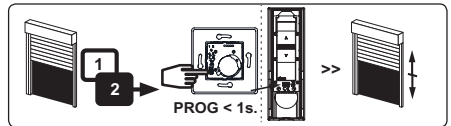

- For group controls, repeat operations 6.1 and 6.2 for each motor in the group.

- For general controls, repeat operations 6.1 and 6.2 for each motor in the installation.

- To delete an transmitter from the memory of a motor, perform operations 6.1 with a programmed transmitter, then perform the operation 6.2 with the transmitter to be deleted.

7 Recording / controlling / deleting intermediate position

Recording:

- Move the motor to the wanted position.

- Press **5 seconds** on the **"Stop"** key. The motor will run for 0,5 second in one direction and then in the other.

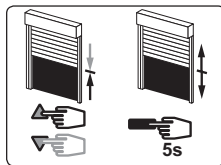

Control:

- Press the **"Stop"** key for **0,5 second**. The motor runs to the intermediate position.

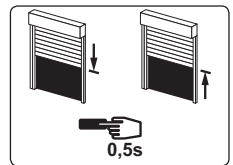

Deleting: Position the motor on the intermediate position. Press **5 seconds** on the **"Stop"** key, the intermediate position is deleted.

i It would be only possible to set or control an intermediate position, after the first two consecutive opening and closing of the shutter (see §7).

8 Modification of the rotation direction (in user mode):

Do not move the roller shutter to the up or down end limit position.

- Press the **"Up"** and **"Down"** buttons simultaneously for **5 seconds**. The motor runs briefly in one direction, then in the other.

- **Within 2 seconds**, press the **Stop** button for **2 seconds**. The motor briefly runs in one direction, then in the other. The rotation direction has been changed.

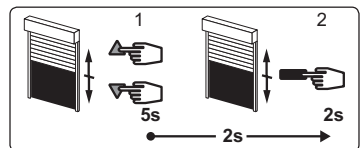

⚠ After stage 1, if no operation is carried out before 2 seconds, the motor runs again briefly in one direction and then in the other, and the rotation direction is not changed.

9 Cancelling programming & settings

- 9.1- Switch off the power supply to the motor for 2 seconds.
- 9.2- Switch the power to the motor back on for 7 seconds.
- 9.3- Switch off the power supply to the motor for 2 seconds.
- 9.4- Switch the power to the motor back on.

If the motor is on the end limit position (up or down), the motor will run briefly in one direction and then in the other, otherwise, the motor runs for 5 seconds in random direction.

The motor is now in the "cancelling mode".

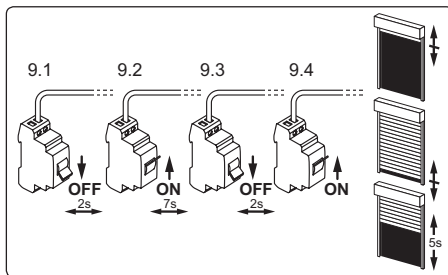

⚠ If you switch off the power to several motors, they will all be in cancelling mode. That is why, you must "eject" out of this mode all the receivers that are not to be deprogrammed by sending a command from their individual control transmitter (UP or Down).

9.5- Then, confirm the cancelling of the concerned motor from the individual control:

- Press the **PROG** key of the transmitter **more than 7 seconds**. **Maintain the pressure** until the motor will first run for 0,5 second in one direction and then in the other, and a few second later, it will run again in both direction.

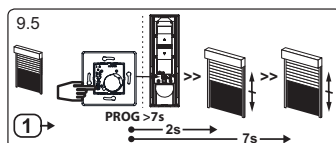

i The motor is now as it was originally configured, and no transmitter and no settings is saved in its memory and is ready for a new programming.

10 Operation and maintenance

- This drive is maintenance-free.
- Press the ▲ button on the control point to raise the motorised product.
- Press the ▼ button on the control point to lower the motorised product.
- If the motorised product is moving: briefly press the "Stop" button, the motorised product stops automatically.
- The motorised product is then stopped, press 0,5s on the "Stop" button. The motorised product moves to the programmed intermediate position. (To modify or delete an intermediate position, see the section §7).

Tips and recommendations for use:

PROBLEMS	POSSIBLE CAUSES	SOLUTIONS
The motorised product does not operate.	The overheating protection on the drive has been activated.	Wait for the drive to cool down.
	The BHz control point battery is low.	Check the battery and replace it as required.

If the motorised product still does not work, contact a drive and home automation professional.

11 Technical Data

- Radio frequency 868-870 MHz, tri-band two-way.
- Frequency bands and Maximum power used:
 - 868.000 MHz - 868.600 MHz ERP <25 mW
 - 868.700 MHz - 869.200 MHz ERP <25 mW
 - 869.700 MHz - 870.000 MHz ERP <25 mW
- Power supply: 230 V ~ 50 Hz
- Operating temperature : - 20 °C to + 60 °C
- Protection rating : IP44
- Safety level: Class I



Simu SAS, F-70103 GRAY as manufacturer hereby declares that the drive covered by these instructions when marked for input voltage 230V~50Hz and used as intended according to these instructions, is in compliance with the essential requirements of the applicable European Directives and in particular of the Machinery Directive 2006/42/EC, and the Radio Directive 2014/53/EU. The full text of the EU declaration of conformity is available at www.simu.com. Emmanuel CARMIER, general director, GRAY, 01/2018.